

**sikla**

# THE MAGAZINE

ISSUE 2023/24

**TOGETHER  
WE BUILD.**

**siklasicher.**

## 20 years of Sikla UK

Sikla UK was founded in May 2003 and since then the company has grown to open new branches in Oceania in 2017, and Belfast in 2022.

The company's 20th anniversary was celebrated in Northampton by employees, past and present, along with members of the owner family. The evening was filled with food, drinks, laughter and sharing memories of Sikla UK over the past 20 years.



## Sikla Slovensko with new location in Bratislava

From October 2023, Sikla Slovensko will be operating from its new location in Bratislava. The new larger office and storage space will allow the company to continue expanding. With the new premises, Sikla Slovensko has expanded its services to offer customers improved technical support, increased product availability and faster delivery. The new premises represents a modern working environment for employees.

*New address:*

*Sikla Slovensko s.r.o. | Stará Vajnorská 4 | 831 04 Bratislava*



## Sikla BV moves into a new office

Sikla BV moved to a modern office in Waalwijk at the start of 2023. Waalwijk is a logistical hotspot in the Netherlands due to its location between the ports of Rotterdam and Antwerp. This region is home to many innovative and internationally active family businesses such as Sikla.

*New address:*

*Sikla B.V. | Industrieweg 48 | 5145 PW Waalwijk*



## Dear Readers,

What sets a company apart and what makes it successful? For me, it is the people who work there. After more than 30 years with the company, I can say that Sikla is a special employer in this respect. The family-owned company gives us employees the freedom to contribute and to develop our potential.

Our support solutions play a key role and we are aware of this responsibility. It is important for Sikla to incorporate the ideas of employees and customers' wishes into our product development. We want to keep improving and offer you reliable products and services.

"Together we build" is an expression of this fundamental belief that we live by. It's part of our DNA and it is also about working with you. We can only achieve the best possible results by working together and without you, we would not exist and we would like to thank you for this.

This issue is all about our new slogan **Together we build. siklasicher.** Find out what siklasicher means for you.

I hope you enjoy the read!

With kind regards

Manuela Maurer  
Corporate Culture & Communications



---

### CORPORATE INFORMATION **sikla**

Editorial department and responsible for the content:  
Sikla GmbH · In der Lache 17 · D-78056 VS-Schwenningen  
Phone +49 (0) 7720 948 0  
[www.sikla.de](http://www.sikla.de)

Printing of this document, including excerpts, requires approval. Copyright notice is required in compliance with § 13 of the German Copyright Act.

---

**We are here to help you. Contact us now!**

#### Export & Overseas Department

Sikla GmbH  
In der Lache 17  
D-78056 VS-Schwenningen  
Phone +49 7720 948 0

Sikla News

02

Modern logistics process Sikla Polska

04

Project report: From planning  
to prefabrication

06

siFramo Ambassador

08

New product: Axial Stop

09

Our sustainability activities

10

Environmental Product Declaration (EPD)

11

What does siklasicher mean

12

## siklasicher means **Safe Supply**

Orders must be delivered to the right place at the right time, in the correct quantity and highest quality.

The Sikla Logistics team ensure that our deliveries arrive safely at their final destination. In this interview, Sikla Polska gives us an insight into their modern logistics process.



Manuela Maurer with Dr. Anna Baraniecka

**The expansion of the warehouse to 3,000 m<sup>2</sup> and the strong market expansion also had an impact on the logistics concept. How have you positioned yourself for the future?**

**Anna Baraniecka:** A modern warehouse infrastructure, innovative management solutions and a committed and motivated team are essential. Based on our development and logistics strategies, we have implemented changes at three levels: organisational structure, interpersonal communication strategy and ability.

**And how was this put into practice?**

**Anna Baraniecka:** On the organisational and mental level, we introduced a new organisational structure to give employees a better understanding of logistics and supply chain management. We have also created key departments with a systemic approach to all processes. The team is now aware of the impact of our work on the company's competitive position and the role it plays in supporting sales. The organisational level also includes the topics of digitisation and automation of processes.

The relationship level is about improving cooperation with our employees, other departments, headquarters and other branches. Here, we have introduced a new communication culture and principles/rules for collaboration.

**Proficiency is an important part of turning “save” into “siklasicher”.**

**Anna Baraniecka:** Yes, that's right. We have set ourselves the goal of expanding the skills of the team. It is important that development in this area goes hand in hand with the principle of specialising. This means that we train experts in certain areas of the logistics process and at the same time ensure a wide range of possible applications. This enables us to avoid negative effects in the event of sudden, adverse changes. Every employee in the Logistics Division knows their professional development path and understands their role in the team.

### How do you manage to implement so many changes while ensuring that day-to-day business is efficient?

**Anna Baraniecka:** This is achieved by working together in a dedicated team with skilled managers in: incoming goods, warehouse management and maintenance, purchasing, prefabrication and distribution. We have also changed the way we implement changes. Employees are involved in the process; they point out problems and suggest solutions. This increases efficiency, commitment and feeling of self-worth, as well as the feeling of being able to act.

### We are convinced that we can achieve more together and this is also reflected in the motto "Together we build".

#### What does the Logistics Division understand by siklasicher?

**Anna Baraniecka:** We are excited about the new marketing message. Even after the first presentation, we understood what we wanted to convey with it. For us, siklasicher primarily means meeting the highest standards in customer logistics and availability. We also combine professional cooperation based on partnership with our suppliers and the safety of our employees.

### You have introduced indicators to support your efforts. Can you give us examples of this?

**Anna Baraniecka:** We work with indicators such as OTIF (On Time in Full) to determine delivery reliability, the carbon footprint or OEE (Overall Equipment Effectiveness) to determine the overall efficiency of our machinery. We want to improve further, introduce and test modern solutions.

### And finally, as always, a personal question. As an experienced expert in logistics, marketing and strategic management, you also work as an academic lecturer. How did you come to Sikla Polska?

**Anna Baraniecka:** I started working for Sikla as a consultant. Even back then, I knew that Sikla Poska was an extraordinary employer. Despite the dynamic development, there is a family atmosphere here and I like the proactivity of the company. Management is open to new ideas, solutions and strongly committed to implementing them. I am grateful to be able to contribute my academic knowledge and consulting experience in the areas of logistics and supply chain management. We are a great, well-coordinated team and I am proud to be a part of it.



*Our goal: provide the highest standards in logistics and availability*



*From left to right: Tomasz Węglarz (Head of Incoming Goods, Warehouse Management and Maintenance, Deputy Director of Logistics), Marcin Tyka (Purchasing Manager), Dr Anna Baraniecka (Director of Logistics), Karol Misakiewicz (Head of Shipping) and Tomasz Gola (Head of Pre-Assembly).*

## siklasicher means **Safe Planning**

Because we plan siklasicher from the beginning, our customers can rely on a secure solution at the end. Sikla can support you at every stage of the project.



© Covalent Lithium

From design to prefabrication, Sikla Oceania's involvement in the Covalent Lithium refinery project

Covalent Lithium is striving to deliver clean energy on a large scale. Globally there is an increased demand for battery-grade materials in which Lithium Hydroxide (LiOH) plays an important role. Covalent is constructing a Mine and Concentrator 400km East of Perth and a Refinery 35km South of Perth in the industrial district of Kwinana.

Once completed (2025), the project will produce 50,000 tonnes of battery-grade LiOH per year.

Sikla Oceania engaged with Covalent in the early stages of the refinery project to provide engineering and construction modelling of mod-

ular piping and HV cable ladder supports. Over 250 tonnes of siFramo material was cut and pre-fabricated in our Canning Vale warehouse to create secondary steel support frames. Delivery was made directly to the site. During the project, Sikla had direct involvement with the SMP (Structural Mechanical Piping) contractor in the procurement of materials.

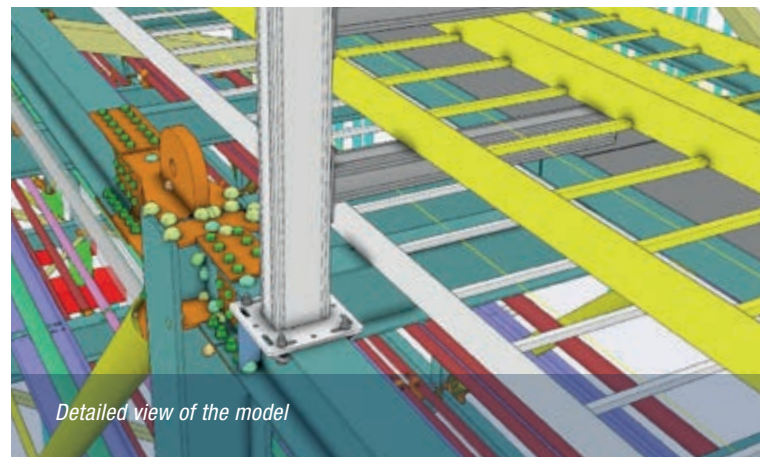

*Detailed view of the model*

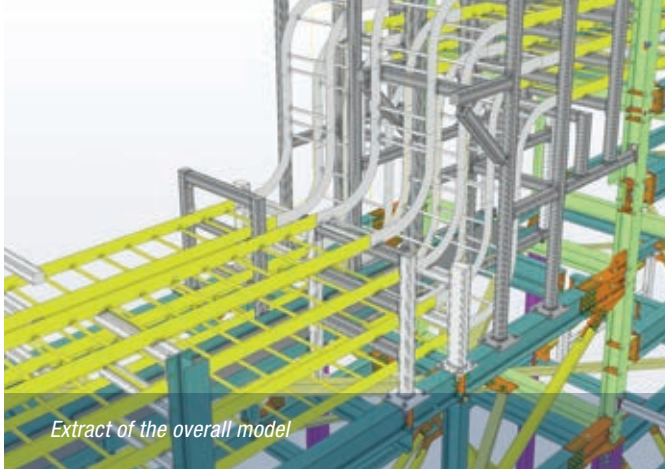

Extract of the overall model

## Bespoke siklasicher planning services

For this project, Sikla supports for the general steel design were in TEKLA. Thus, the design of supports preceded the completion of pipe and cable containment detailing.

During the design stage, Sikla Oceania provided engineering and construction modelling of supports, to integrate with the client's engineer. Working on a 2 milestone design workflow, models were integrated into Navisworks and Trimble Connect to coordinate within the federated model, perform clash detection and revision management.

Using Aveva's iConstruct software, Sikla has successfully supplied data-rich models to the client and SMP contractor with all the vital information to execute the project efficiently. This included material tracking, order process and cost control.

As a part of the procurement and fabrication of material, Sikla was required to produce MTOs (Material Take Off) and assembly drawings. Over 7000 prefabricated supports were supplied to the SMP contractor for installation. The majority of supports designed for the project used our MS 5P Assembly Set. This Assembly Set requires no hot work to assemble therefore is quick and simple to install, allowing the ability to adjust onsite to variations in construction tolerances and design changes.

The supports were supplied fully palletised with corresponding pallet overviews and weights in line with construction work packs and site requirements.

*“Besides the inherent versatility, using the Sikla SiFramo system allowed the design team to start structural detailing and fabrication before substantial completion of design and routing of piping and electrical services. Sikla supported the effort as part of the design team and performed admirably for their first significant foray into such an undertaking. The support we received on this project is commendable and the system is living up to all expectations.”*

DAVID BRYDEN –  
LEAD STRUCTURAL ENGINEER (COVALENT)

## The Project in Figures

- ◆ Over 7,000 supports
- ◆ Over 250 tonnes of material
- ◆ Implementation by Sikla UK (Planning) and Sikla Oceania (Prefabrication and Delivery)



Clamped assembly with the MS 5P Assembly Set



Ready-to-deliver pre-assembled brackets in Canning Vale

## siklasicher means **Safe Products**

Our solutions play a key role. We are aware of our responsibility That is why we rely on uncompromising quality in all aspects of our products and system solutions.

## **siFramo** Impressing Our Clients



### **In conversation with Rui Pereira**

Area Manager,  
Climacer S.A., Portugal

*Climacer, S.A. is a company specialized in special MEP (Mechanical, Electrical and Plumbing) installations covering Design, Production, Commissioning, Service and Sustainability.*

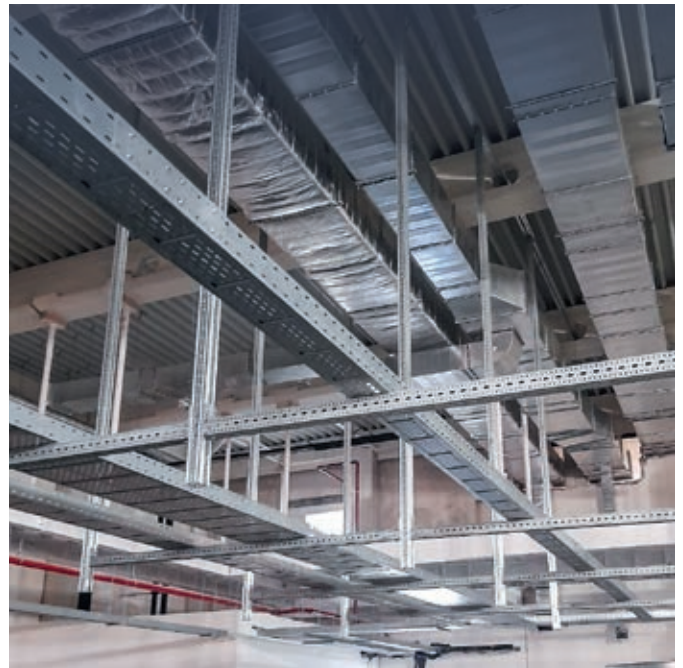

### **Since when has siFramo been used at Climacer and what are the most important advantages for you?**

Climacer are using the siFramo system since 2017. It has revolutionized the way we think about the realization of support structures in the field of HVAC and hydraulics. We carry out all plant room support structures indoors and outdoors with the siFramo product range. This gives us many advantages. In my opinion, the main advantages lie in the versatility of applications, as well as the speed and simplicity of assembly.

### **Can you give us an example of how these benefits show up in practice?**

In constructing MEP installations, plant rooms are the heart of the systems. Due to the long planning times, we have to carry out the installation in record time in the execution phase. siFramo has now become an indispensable tool for us to be able to meet the needs of our customers in terms of deadlines and quality. With siFramo, we can also react quickly to adjustments that are required at short notice.

### **How has siFramo contributed to the success of your work in terms of efficiency or other relevant aspects?**

Compared to conventional steel beams, the use of siFramo saves us a significant amount of time during execution. I can say that the assembly time has been reduced by more than half. We were also able to significantly reduce the use of hoists. All of this translates into cost savings and simpler logistics. During the construction phase we are constantly dealing with factors such as the maximum permissible weight on roofs or ceilings, compatibility with other trades, etc. We can meet these challenges by using siFramo because it optimally suits our needs. For us, this system offers technical and financial added value.



## Axial stop – a siklasicher product without welding

The use of Axial stops enables controlled pipe routing, secures risers against slipping and allows thermal expansion. An additional benefit is the flexible sliding distance which can be achieved on both siFramo and traditional steel beams. Axial stops can be found in all Sikla software tools and are readily available from stock. The tested safety, following the EC3 assessment base, ensures easy acceptance on-site.

### For siFramo beam profiles TP F 80/100

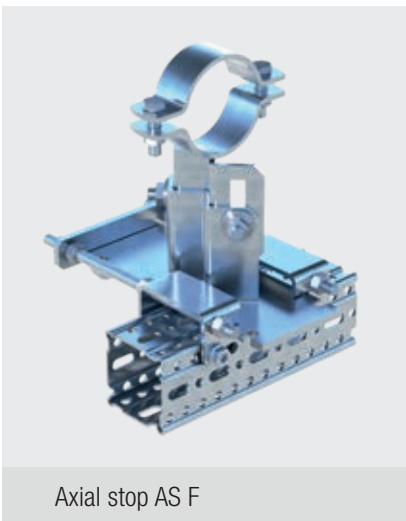

### For Simotec beam profiles TP 100/120 and steel beams

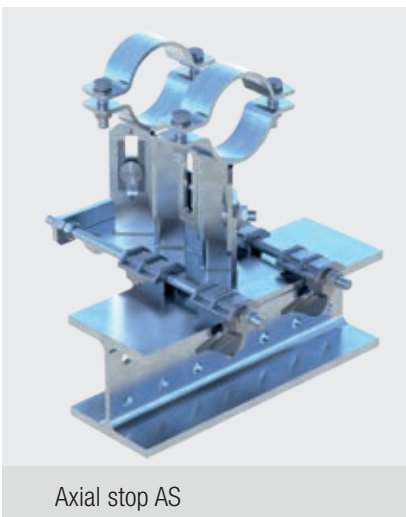

#### Available in the software tools:

- ◆ Revit
- ◆ Cadenas
- ◆ S3D
- ◆ PDMS
- ◆ E3D

Further information can be found in the Simotec section “Pipe shoes” at [www.sikla.com](http://www.sikla.com)

Max. beam flange thickness  
 $t \leq 30 \text{ mm}$

Beam width 80 – 300 mm

# siklasicher means a Safe Future

Helping to shape the future is our ambition. We are aware of the social and environmental impact of our operations and are continuously looking to improve our sustainability performance within Sikla's future strategy.

## Sustainability is an essential part of our strategy

From 2030, we aim to operate as a 100% climate-neutral company in all areas and offset unavoidable emissions. Sikla's sustainability policy is based on the United Nations' Sustainable Development Goals.

Through our corporate culture, we promote ethical and resource-conserving behaviour among our employees. A code of conduct for suppliers ensures that the set standards are also implemented in the supply chain.

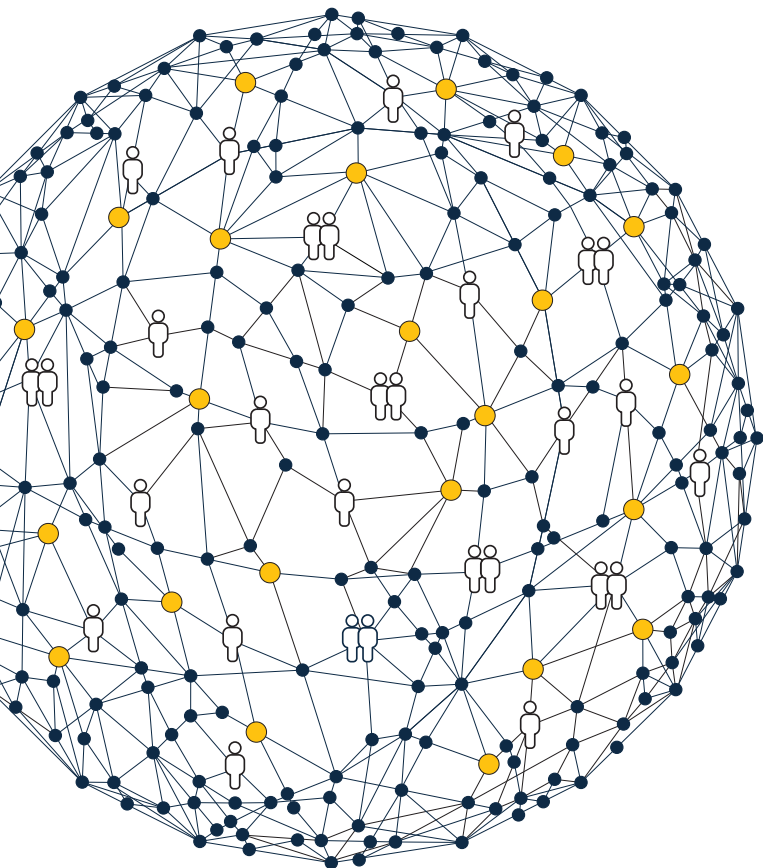

As a signatory of the United Nations Global Compact, we make our commitment to human rights, working standards, environmental protection and anti-corruption public. We see ourselves as responsible for achieving the Sustainable Development Goals within the scope of our abilities. The United Nations Global Compact is a global initiative for sustainable corporate governance. Based on 10 universal principles and 17 global sustainability goals, it pursues the vision of a more inclusive and sustainable global economy for the benefit of all people, communities and markets.



The biggest platform for Eco-Vadis sustainability ratings has evaluated our sustainability management. With the bronze medal, Sikla is one of the top 50% of companies evaluated. We want to continue to improve and aim for silver by 2026 and gold by 2030.

Following the environmental standard DIN EN ISO 14001, Sikla is responsible for the use of natural resources. The goal of this certification is to improve protection, reduce the impact and implement environmental objectives correctly. Sikla UK and Oceania are currently working to obtain the ISO 14001 certification.

These are key milestones on our path to achieving a climate-neutral company by 2030.



**Doreen Volz**  
Sustainability  
Management HQ

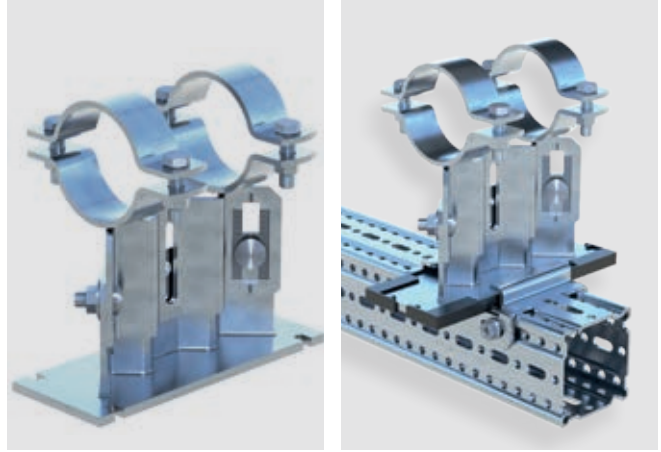

## Environmental Product Declaration (EPD)

### On the path to sustainable system

Striving for sustainability in the use of resources has become a central topic within our society. There is an increasing demand for information on potential environmental impacts such as climate change or the shortage of raw materials. Declarations are requested for sustainability certifications of buildings.

The Environmental Product Declaration (EPD) contains data on the environmental impact of a product or building material during its lifetime. It is based on relevant standards and provides uniform, fact-based information for evaluating a product's sustainability. This enables a well-founded comparison of the CO<sub>2</sub> consumption.

Each EPD takes a closer look at the five stages of a product's life from raw material extraction to disposal. The processes related to the product, such as packaging and transport are also included.

As a first step, Sikla planned for EPDs for the siFramo mounting system and pipe support range. The disposal stage was examined in more detail based on two scenarios. Both product systems can be reused and recycled. After disassembly, both products can be transported to a new location and reused. The reject rate is approximately 10% for the beam profile, as this must be considered for the new application.

These measures make an active contribution to sustainability

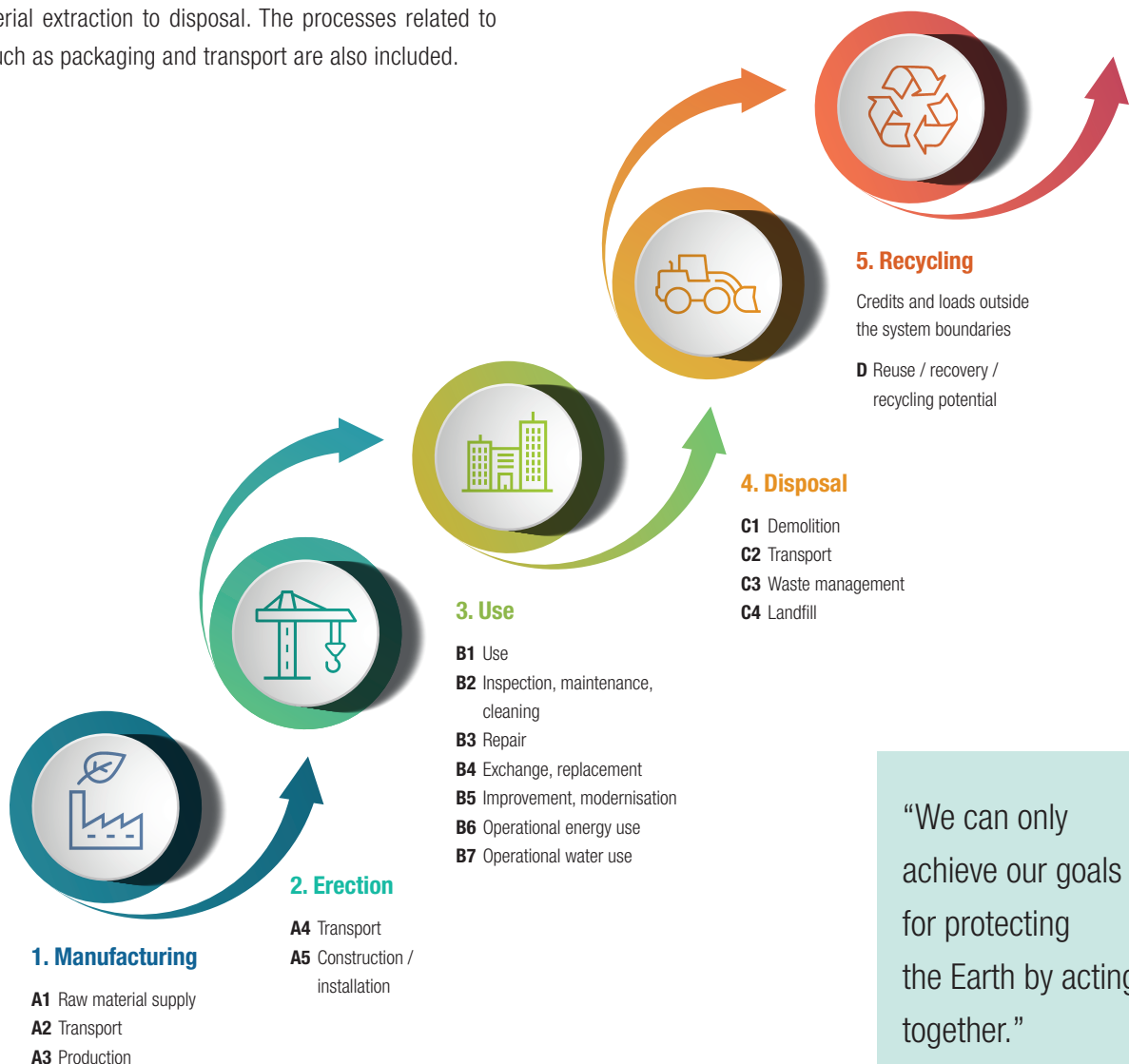

“We can only achieve our goals for protecting the Earth by acting together.”

**siklasicher.**

# That's our promise. For your success.

Since Sikla was founded in 1967, we have been committed to the principle: make it siklasicher.

We offer support solutions and services that you can rely on. siklasicher is our promise to find the best, smartest and safest solution for you: from detailed planning and logistics to installation, recycling and reuse of our modular solutions.

We want you, our customers, to always rely on us to feel siklasicher. siklasicher is our mission and our goal.

siklasicher stands for:



**Safe products**



**Safe planning**



**Safe supply**



**A safe future**